



# TYPHOON INTAKE SYSTEMS

SOME INTAKE SYSTEMS ARE NOT LEGAL FOR SALE OR USE ON ANY POLLUTION CONTROLLED MOTOR VEHICLE IN CALIFORNIA OR STATES ADOPTING CALIFORNIA EMISSION PROCEDURES.

See knfilters.com for CARB status on each part for a specific vehicle

## INSTALLATION INSTRUCTIONS

69-2020TP  
69-2020TR  
MINI  
2000-06 Cooper  
L4-1.6L  
2000-06 One  
L4-1.6L

NOTE: C.A.R.B. E.O. # D-269-37 APPLIES ONLY TO 2002-2006 MINI COOPER MODEL YEAR VEHICLES

### TOOLS NEEDED:

- 6" Extension
- 8mm Socket
- 12mm Socket
- 3mm Allen Wrench
- 4mm Allen Wrench
- Flat Blade Screwdriver
- Needle Nose Pliers
- Pliers
- Ratchet
- Side Cutters

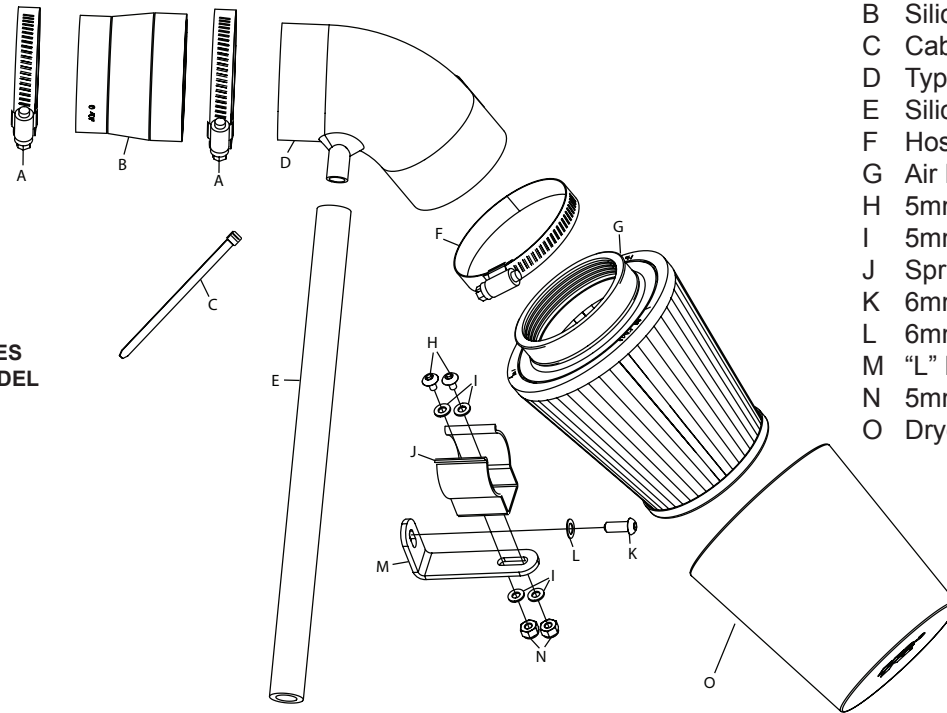

### PARTS LIST:

Description	Qty.	Part #
A Hose Clamp, #44	2	08560
B Silicone Hose, Black	1	084016
C Cable Tie	1	21589
D Typhoon® Intake Tube	1	27107
E Silicone Hose, 1/2"ID x 12"L	1	087031
F Hose Clamp, #44	1	08577
G Air Filter	1	RC-9350
H 5mm Button Head Screw, 12mm L	2	07734
I 5mm Flat Washer	4	08212
J Spring Holder, Black	1	08308
K 6mm Button Head Screw, 12mm L	1	07794
L 6mm Wave Washer	1	08277
M "L" Bracket	1	070742
N 5mm Nylock Hex Nut	2	07507
O Drycharger®	1	RC-9350DK

**NOTE: FAILURE TO FOLLOW INSTALLATION INSTRUCTIONS AND NOT USING THE PROVIDED HARDWARE MAY DAMAGE THE INTAKE TUBE, THROTTLE BODY AND ENGINE.**

### TO START:

1. Turn off the ignition and disconnect the negative battery cable.

**NOTE: Disconnecting the negative battery cable erases pre-programmed electronic memories. Write down all memory settings before disconnecting the negative battery cable. Some radios will require an anti-theft code to be entered after the battery is reconnected. The anti-theft code is typically supplied with your owner's manual. In the event your vehicles' anti-theft code cannot be recovered, contact an authorized dealership to obtain your vehicles anti-theft code.**

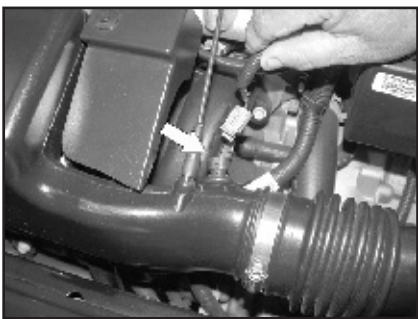

2. Remove the stock crankcase vent hose from the cam cover as shown.

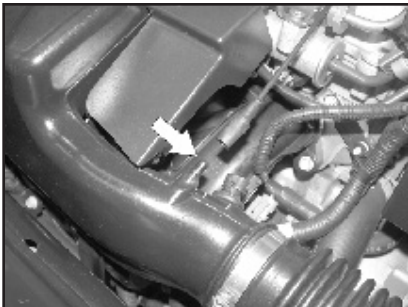

3. Using a pair of side cutters cut the factory hose clamps on the stock intake tube at the throttle body and at the air cleaner assembly as shown.

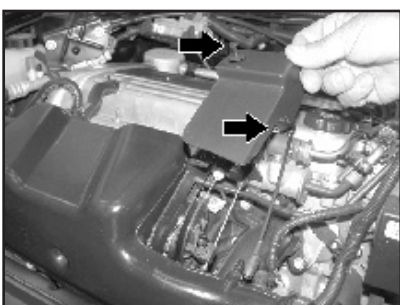

4. Remove the stock intake tube as shown.

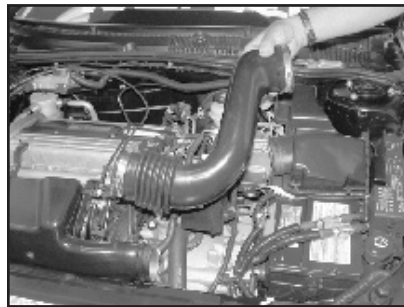

5. Remove the harness multi plug from the side of the air cleaner assembly.

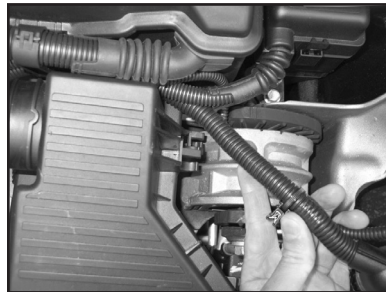

6. Using a pair of needle nose pliers unclip the electrical harness from the side of the airbox assembly as shown.



7. Models between April 2001-2004: Remove the two bolts that secure the air cleaner assembly as shown.

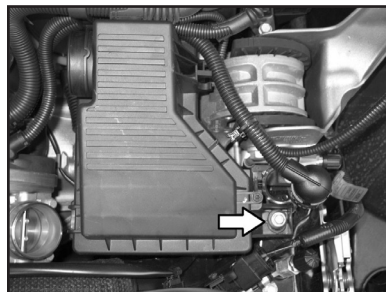

8. Models from 2005: Remove the single bolt that secures the air cleaner assembly as shown.

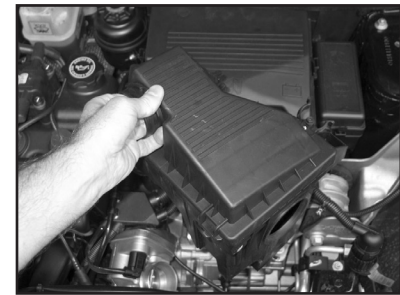

9. Remove the air cleaner assembly from the vehicle as shown.  
**NOTE: Pull firmly upwards while moving the assembly in a side to side motion to remove.**  
**NOTE: K&N Engineering, Inc., recommends that customers do not discard factory air intake.**



10. Remove the foam feed pipe from between the intake scoop & resonator box as shown.



11. Secure the silicone stepped hose and hose clamps onto the throttle body as shown.

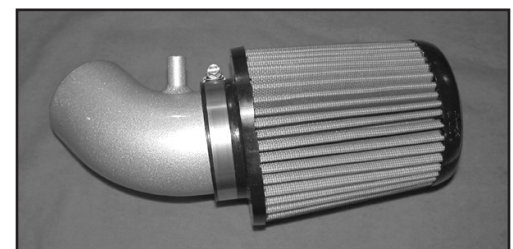

12. Install the air filter onto the intake tube as shown.  
**NOTE: Before installing the air filter, inspect the inside of the tube for any debris, then clean the inside out with water and a towel. Inspect the tube one more time before proceeding to the next step.**



13. Slide the intake tube assembly into the silicone stepped hose & adjust for best fit & clearance as shown.

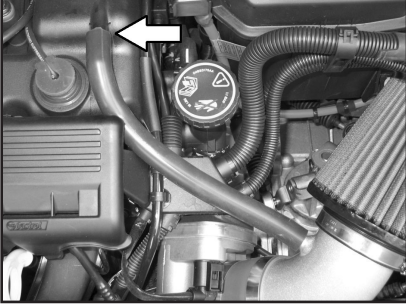

14. Install the provided silicone hose onto the crankcase vent on the cam cover, then, attach the other end onto the vent on the intake tube as shown.



15. Assemble the two provided brackets using the provided hardware as shown.

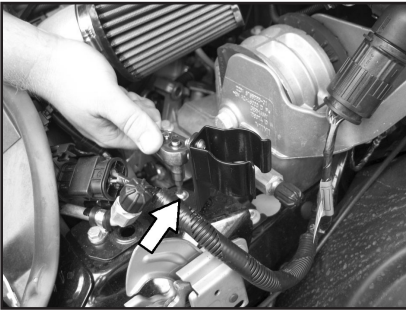

16. Install the bracket assembly to the original air cleaner mounting point using the provided hardware as shown.

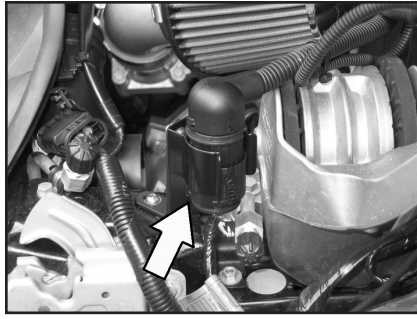

17. Slide the harness multi plug into the bracket as shown.



18. Secure the harness away from the air filter using a provided plastic tie as shown.



19. Reconnect the vehicle's negative battery cable. Double check to make sure everything is tight and properly positioned before starting the vehicle.

20. The C.A.R.B. exemption sticker, (attached), must be visible under the hood so that an emissions inspector can see it when the vehicle is required to be tested for emissions. California requires testing every two years, other states may vary.

21. It will be necessary for all K&N® high flow intake systems to be checked periodically for realignment, clearance and tightening of all connections. Failure to follow the above instructions or proper maintenance may void warranty.

#### ROAD TESTING:

1. Start the engine with the transmission in neutral or park, and the parking brake engaged. Listen for air leaks or odd noises. For air leaks secure hoses and connections. For odd noises, find cause and repair before proceeding. This kit will function identically to the factory system except for being louder and much more responsive.

2. Test drive the vehicle. Listen for odd noises or rattles and fix as necessary.

3. If road test is fine, you can now enjoy the added power and performance from your kit.

4. K&N Engineering, Inc., suggests checking the air filter element periodically for excessive dirt build-up. When the element becomes covered in dirt (or once a year), service it according to the instructions on the Recharger® service kit, part number 99-5050 or 99-5000.

**SOME INTAKE SYSTEMS ARE NOT LEGAL FOR SALE OR USE ON ANY POLLUTION CONTROLLED MOTOR VEHICLE IN CALIFORNIA OR STATES ADOPTING CALIFORNIA EMISSION PROCEDURES.**

See [knfilters.com](http://knfilters.com) for CARB status on each part for a specific vehicle